

General information

Antenna covering NB-IoT Band 8 and 20 (791 - 960 MHz), GSM 900 (880 - 960 MHz), GSM 1800 (1710 - 1880 MHz), GSM 1900 (1850 - 1990 MHz) and UMTS 2100 (2110 - 2170 MHz) for inside mounting on non-conductive surfaces, such as plastic. The antenna can also be mounted on uneven surfaces.

InSide GSM/NB-IoT Flex is a ground plane independent antenna including coaxial cable with MHF or MHF4 connector, supplied with adhesive.

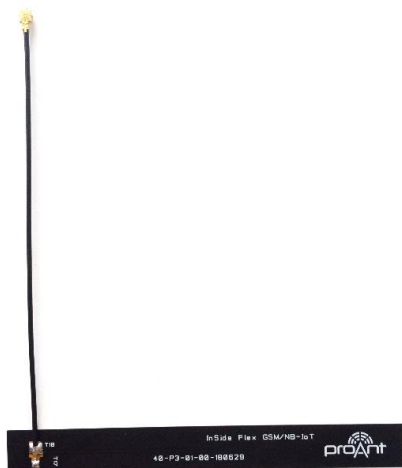

Technical data

Frequency	791 - 960, 1710 - 2170 MHz
Return loss*	< -7.6 dB, 791 - 960 MHz < -6.0 dB, 1710 - 2170 MHz
Efficiency*	> -2.6 dB (55%), 791 - 960 MHz > -2.4 dB (58%), 1710 - 2170 MHz
Gain*	Max 5.3 dBi, 791 - 960 MHz Max 2.9 dBi, 1710 - 2170 MHz
Dimension	10.00 x 93.00 mm, thickness 0.13 mm
RoHS status	Compliant with EU directive 2011/65/EU and 2015/863
Mounting	Adhesive tape
Temperature	-40 to +85° C
Flammability	Compliant with UL 94-V0

Applications

- IoT devices
- M2M-communications
- Telemetry
- Automated meter reading
- Alarms

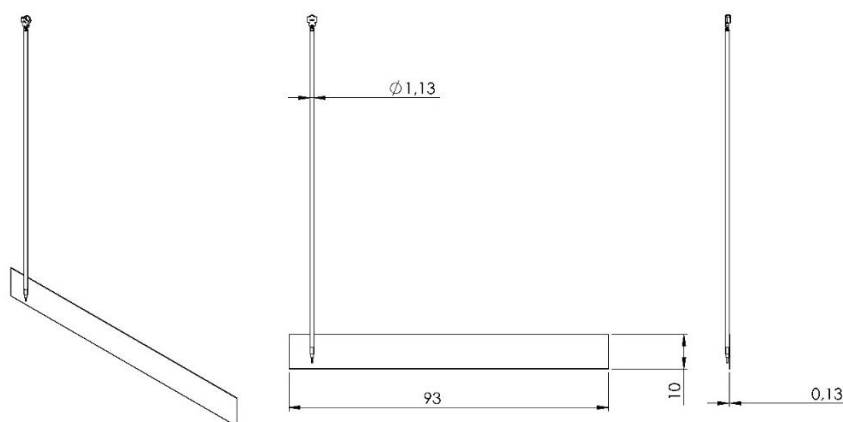

Antenna drawing. Above dimensions are given in millimeter.

*Measured on Proant standard measurement fixture, see next page for more information.

Electrical performance

Measurement setup

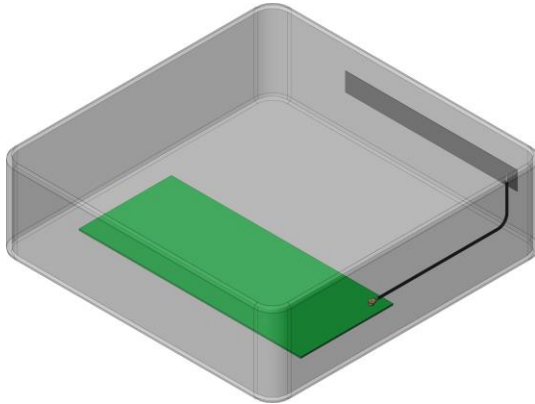

The antenna measurements were done on Proant's standard measurement fixture - the antenna mounted in an ABS plastic box, 150x150x45 mm, connected to a PCB, 120x150 mm, with the cable fully extended.

Return loss

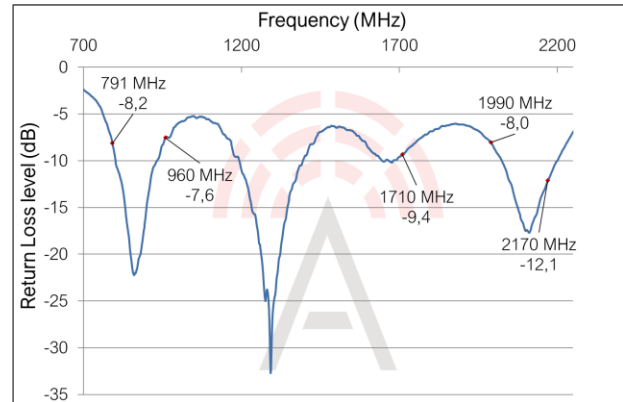

Total radiation efficiency

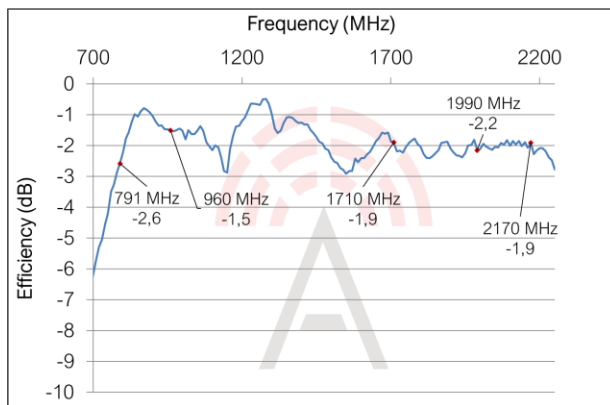

Maximum radiation gain

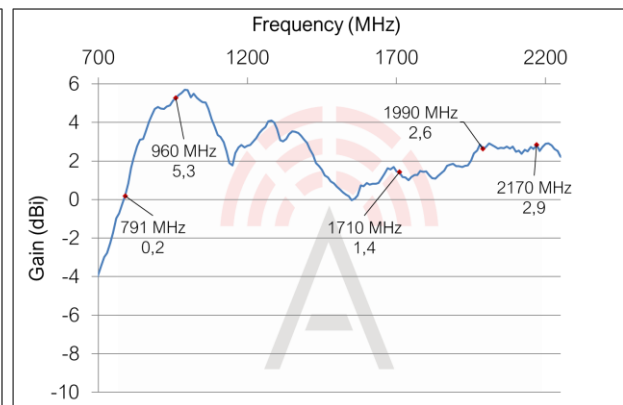

Radiation pattern, 870 MHz

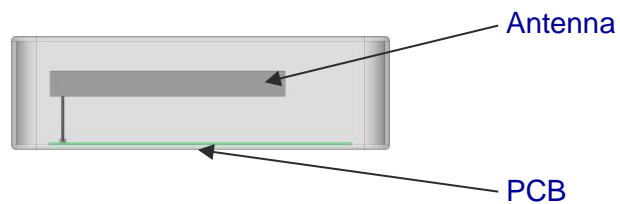
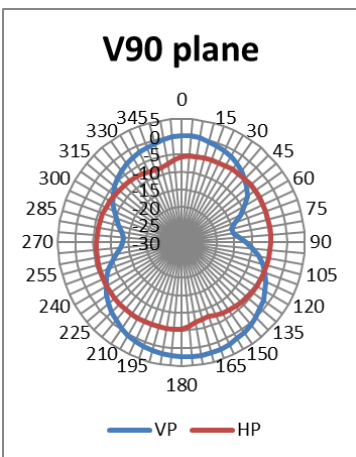
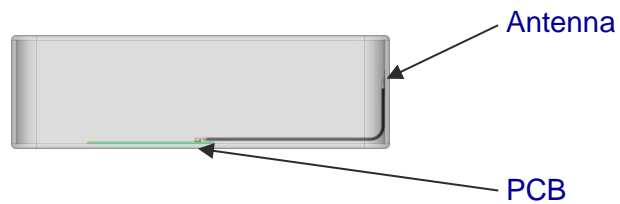
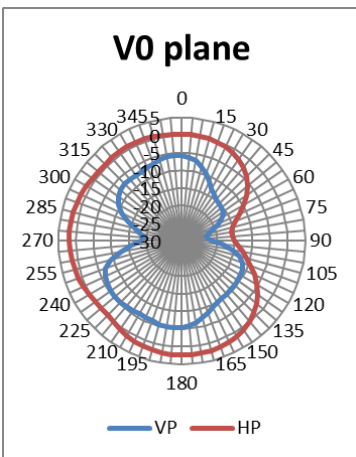
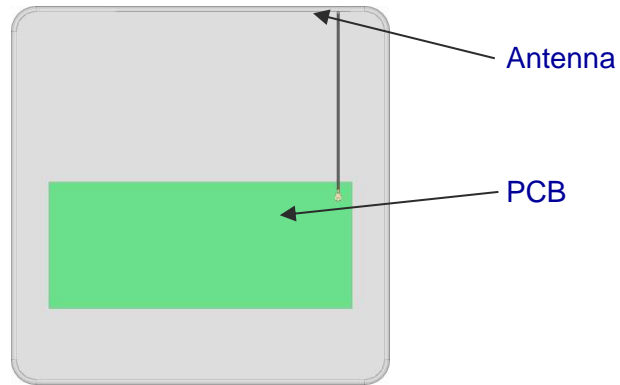
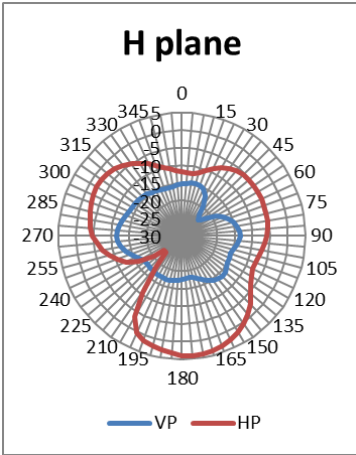

Radiation pattern, 1850 MHz

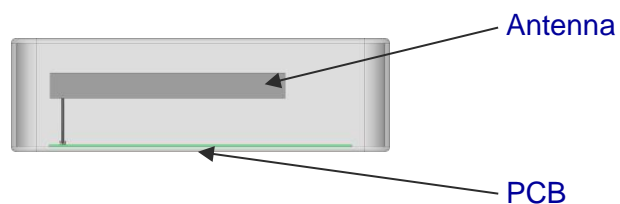
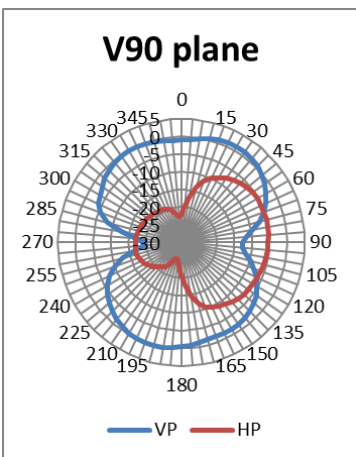
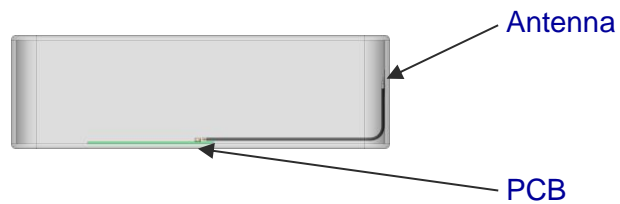
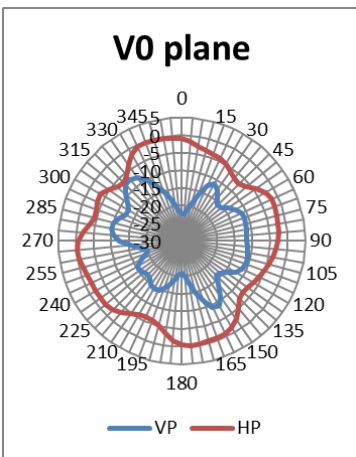
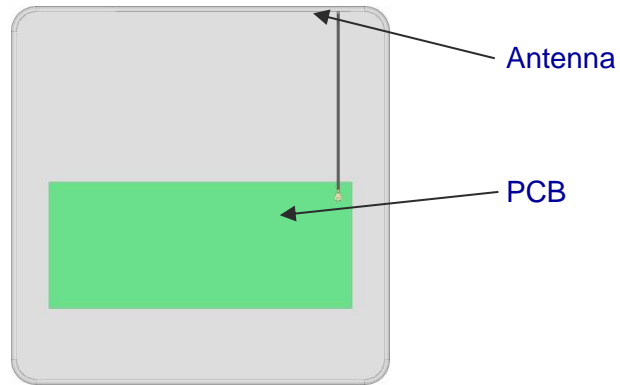
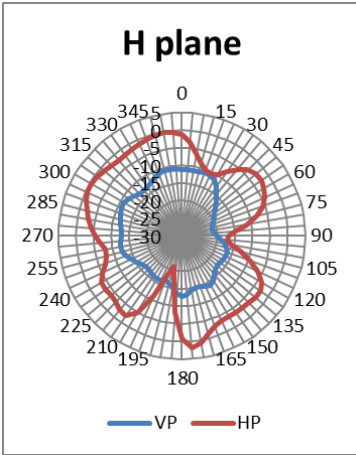

Radiation pattern, 2100 MHz

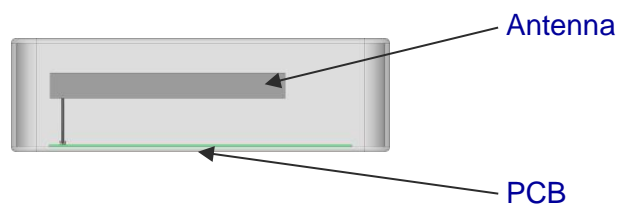
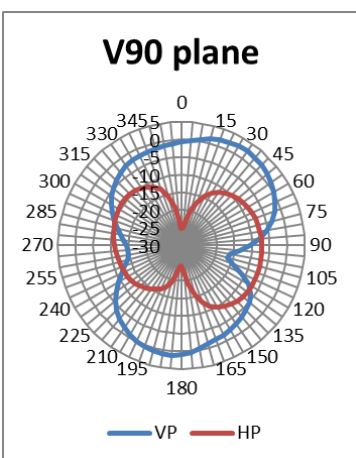
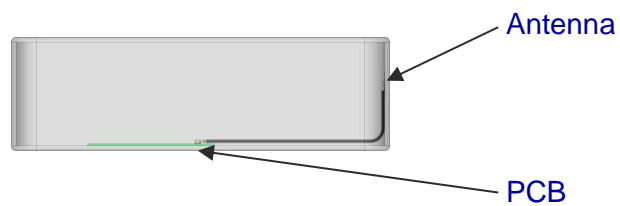
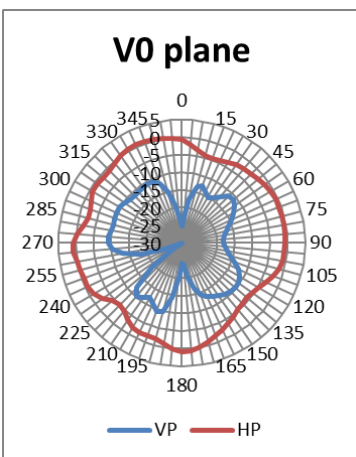
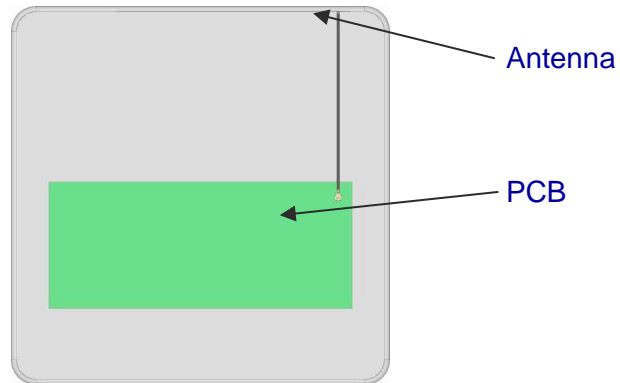
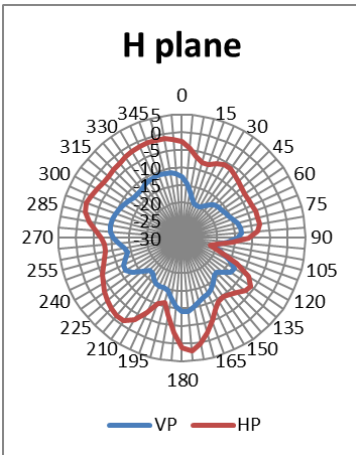

Intended applications

The antenna is optimized for pentaband operation in the GSM, UMTS and NB-IoT systems, which is defined by several frequency bands. Some of the supported bands are:

GSM/GPRS/EDGE	GSM 850 (824 – 894 MHz)
	GSM 900 (880 – 960 MHz)
	GSM 1800 (1710 – 1880 MHz)
	GSM 1900 (1850 – 1990 MHz)
UMTS/LTE	Band 2 (1850 – 1990 MHz)
	Band 3 (1710 – 1880 MHz)
	Band 5 (824 – 894 MHz)
	Band 6 (830 – 883 MHz)
	Band 8 (880 – 960 MHz)
LoRa	EU 863-870 MHz
	US 902-928 MHz
	AU 915-928 MHz
Sigfox	868 MHz
NB-IoT	Band 8 (880 - 960 MHz)
	Band 20 (791 - 862 MHz)

Ordering information

Part number	Part name	Details
PRO-IS-577	InSide GSM/NB-IoT Flex, 100 mm MHF	Antenna for NB-IoT and GSM. 100 mm cable with MHF (U.FL) connector.
PRO-IS-590	InSide GSM/NB-IoT Flex, 100 mm MHF4	Antenna for NB-IoT and GSM. 100 mm cable with MHF4 connector.

For information on sales, delivery terms and conditions and prices, please visit the Proant website (www.proant.se) for a complete list of distributors.

Proant offers consultation with design-in of the InSide antennas. Proant have all necessary capabilities for antenna design including anechoic chamber and prototype workshop. Please send your requests to info@proant.se.

Disclaimer

The information given in this application note shall in no event be regarded as a guarantee of conditions or characteristics. With respect to any examples or hints given herein, any typical values stated herein and/or any information regarding the application of the device, Proant AB hereby disclaims any and all warranties and liabilities of any kind, including without limitation, warranties of non-infringement of intellectual property rights of any third party.